

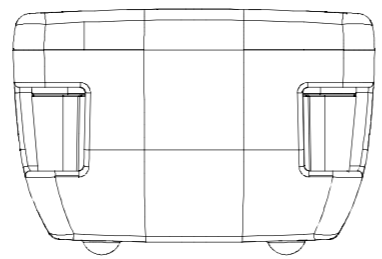

図番
DRAWING NO.

8 記号 MARK △	9 座標 COORDINATES	9 日付 DATE	10 変更記事 ALTERATIVE ARTICLE	11 担当 NAME	承認 APPROVED
----------------------	------------------------	-----------------	----------------------------------	------------------	----------------

A
B
C
D
E
F
G

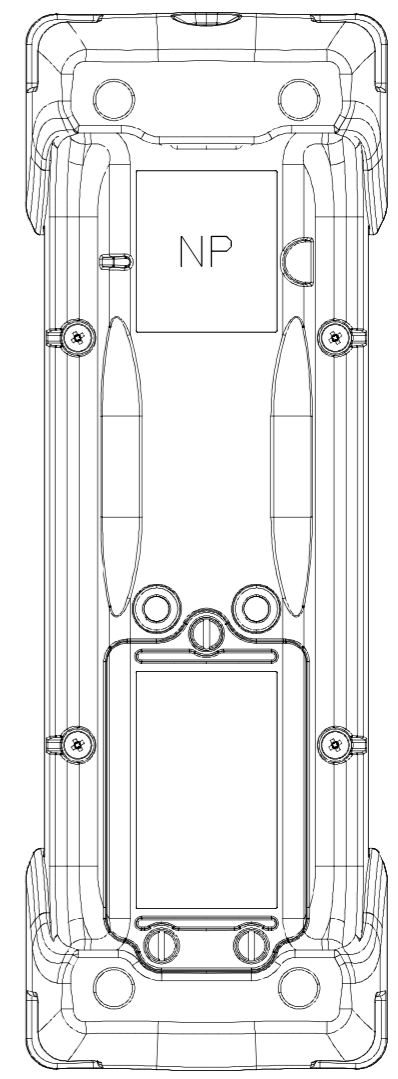
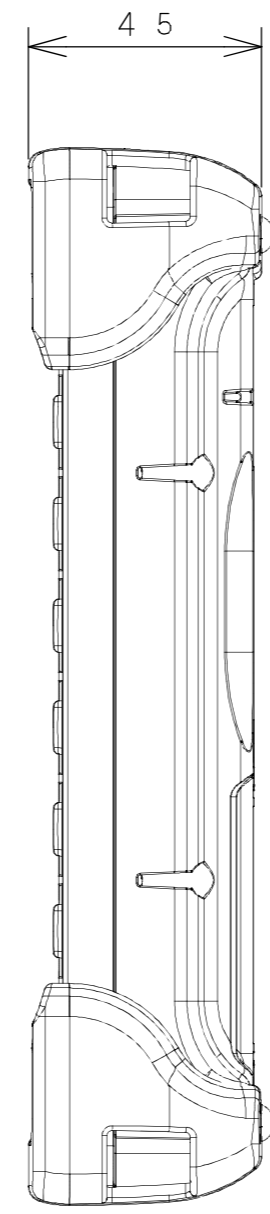
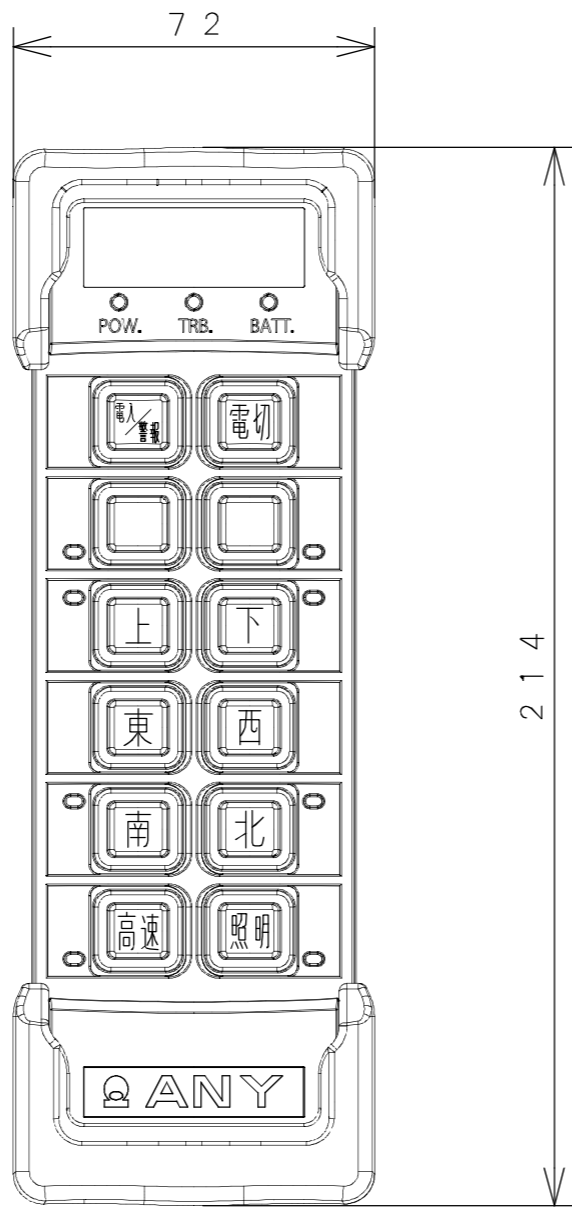
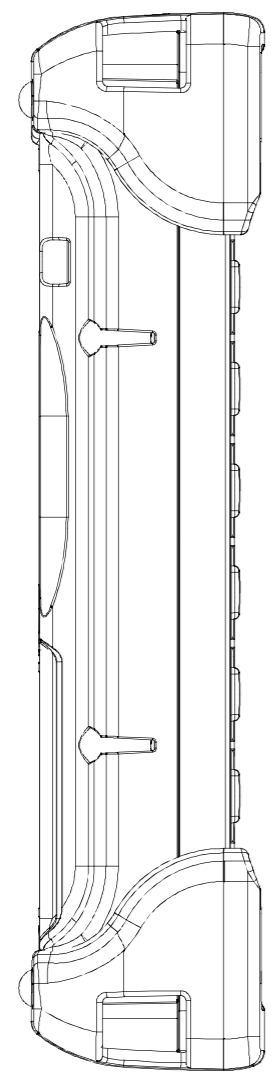
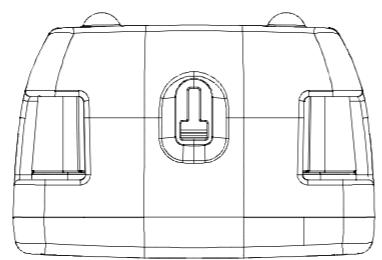

9	
8	
7	
6	
5	
4	
3	
2	
1	
PAGE	

記事 NOTE	FZシリーズ	第3角法 3RD ANGLE PROJECTION	写図 DRAWN: . . .	 株式会社 工 二 一 ANY & CO., LTD.	
材料 MATERIAL		単位 UNITS MM	製図 DESIGNED: . . .		
処理 TREATMENT	数量 PIECE	尺度 SCALE 1 1.5	設計 PLANNED: . . .	名称 TITLE	
仕上 FINISH	台 1SET		検図 CHECKED: . . .	承認 APPROVED: . . .	無線遠隔制御装置 FTH120VZ 外觀図
				図番 DRAWING NO.	Z0001-345